

MassWildlife Homeowner's Guide To Bats



Massachusetts

Division of Fisheries & Wildlife

MassWildlife Homeowner's Guide To Bats



MassWildlife

by

**Thomas W. French¹
James E. Cardoza¹
Gwilym S. Jones²**

Illustrations by Matt Burne and Laszlo Meszoly

3RD Edition

¹ Massachusetts Division of Fisheries & Wildlife, Field Headquarters,
One Rabbit Hill Road, Westboro, MA 01581

² Department of Biology, Northeastern University, Boston, MA 02115

Publication of this document approved by State Purchasing Agent.

Printed on Recycled Paper

3 M - 6/02 Cost per Copy \$0.36 - DFW



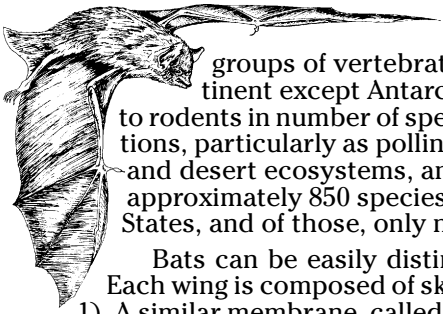

Bats are among the most numerous and diverse groups of vertebrates inhabiting the planet, occurring on every continent except Antarctica. Among the mammals, they are second only to rodents in number of species. They perform many critical ecological functions, particularly as pollinators and seed distributors in tropical rainforest and desert ecosystems, and consume immense numbers of insects. Of the approximately 850 species of bats in the world, only 39 occur in the United States, and of those, only nine occur in Massachusetts.

Bats can be easily distinguished from all other animals by their wings. Each wing is composed of skin stretched between four elongated fingers (Fig. 1). A similar membrane, called the interfemoral membrane, is situated between the hind limbs and tail of all North American bats. It is supported in part by a flexible spur, called the calcar, on the heel of each hind foot.

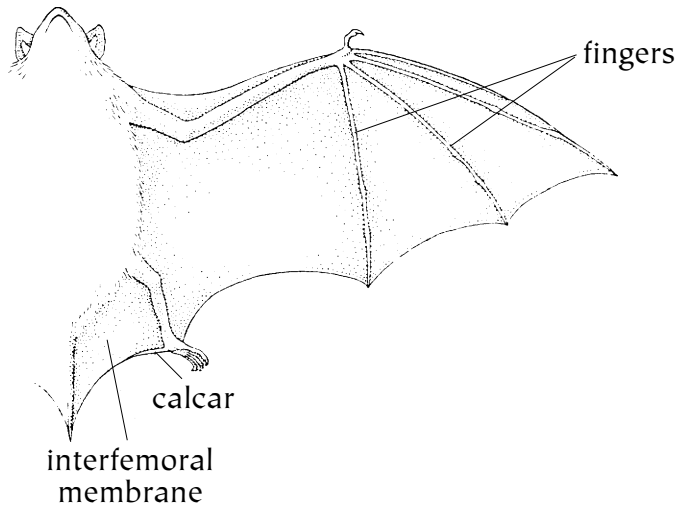

Figure 1. Illustration of a bat showing the four elongated fingers in the wing, the interfemoral membrane, and the calcar.

Natural History

All species of bats in Massachusetts are insect eating (insectivorous) bats in the family Vespertilionidae. All are active at night and occasionally at dawn and dusk. They locate their insect prey by means of a “sonar-like” echolocation system. This ability permits them to capture tiny insects in the dark and to avoid flying into objects. During the winter, when their insect prey is not available, bats either hibernate or migrate to warmer regions farther south.

Beneficial Aspect

Bats are of immense benefit to humankind in that they consume great quantities of noxious insects such as mosquitoes. Dr. Merlin Tuttle of Bat Conservation International reports that the gray bat, which is closely related to several species in Massachusetts, consumes as many as 3,000 small insects in a night. In the Boston area, Dr. Thomas Kunz of Boston University estimates that 14 to 15 tons of insects are consumed each summer by the 50,000 big brown bats that live within the bounds of Route 128. Among vertebrates, bats are the greatest nocturnal predators of flying insects.



Figure 2. Examples of an unkeeled (left) and keeled (right) calcar on the feet of two bats. This character is important in identifying certain bat species.

House Bats

During the warmer months, most bats found in buildings in the Commonwealth are either little brown bats or big brown bats. Occasionally, the northern long-eared bat may enter buildings; very rarely the eastern pipistrelle will do so. During the winter the big brown bat is the only bat that normally inhabits buildings.

Bats in the Home

The presence of any wild animal in a home is an obvious indication that the house is not weather-tight. Finding the site(s) where bats enter the house may be as simple as locating an open chimney flue or cellar hatch, or as difficult as finding a narrow crack between a wall and a chimney or eave. The attention of a carpenter is often required.

How to Evict a Bat

The discovery of a bat flying through the house can create anything from excitement to hysteria within a family. Fortunately, a single bat usually can be dealt with quite easily. It will **not** become tangled in your hair or attack, although it may flutter by close enough for you to feel the light breeze from its wingtips. The best action is to put away that broom or tennis racket and open a window or door so the bat can fly out. If possible, close off the room containing the bat and open a window in that room. Using its “sonar,” a flying bat will usually circle the room several times until it locates the open window, whereupon it will immediately fly out. If possible, stay in the room with the lights on and watch to be sure the bat leaves. (For some people, leaving the bat alone to find its way out may be the preferred plan.) It is usually only a matter of a few minutes before the bat leaves the house.

A bat that flies into a room and then disappears has probably landed behind a curtain, picture frame or some other nook or cranny. In this event, open the window, turn out the lights, close the door and block the space under the door with towels. If it is nighttime, the bat should find its way out through the window almost immediately; if it is daytime, it will probably leave within an hour after dark. As long as the weather outside is not too cold, this method should do the trick.

A bat that has landed can be assisted out of a house in several ways. If it has landed on a curtain, place a jar or coffee can over the bat. Carefully work the animal into the container, then slip the lid on quickly. A bat on the floor can be covered with a towel and picked up within the towel. No species of bat that occurs in Massachusetts can bite through a thick towel!

Another method is to use leather gloves and simply pick up the bat. Do not use thin cotton gloves and **never** pick up a bat with bare hands. Whatever method used, the bat will open its mouth and squeak loudly when touched. Don't worry. After you have captured the bat, take it outdoors and release it. Do **not** call the local police or fire departments; they have more important duties to perform. Have a neighbor assist if you need moral support.

A Colony in the House

The attic is the most common portion of a house in which bats accumulate in colonies. In the summer, little brown bats and big brown bats commonly use buildings to raise their young. The heat of an attic keeps the babies warm and allows them to grow and develop more rapidly. In late summer, an attic may become too hot for the bats, forcing them into the living quarters as they search for cooler places to roost. On hot summer days, they may be found near the attic door, trying to escape the heat. At such times you might also see them flying around the yard in the daylight. Late summer is also the time of year when young bats are learning to fly. You might find these inexperienced young when they fall down a chimney, come down the attic stairway, fly through an open window or land on the ground.

As cold weather approaches, little brown bats travel great distances to caves and mines in which they spend the winter. One Massachusetts mine contains about 3,500 bats each winter; another in New York about 40,000. Bats come from all over the Northeast to use these sites. The big brown bat, however, often stays in houses, spending the winter in small colonies.

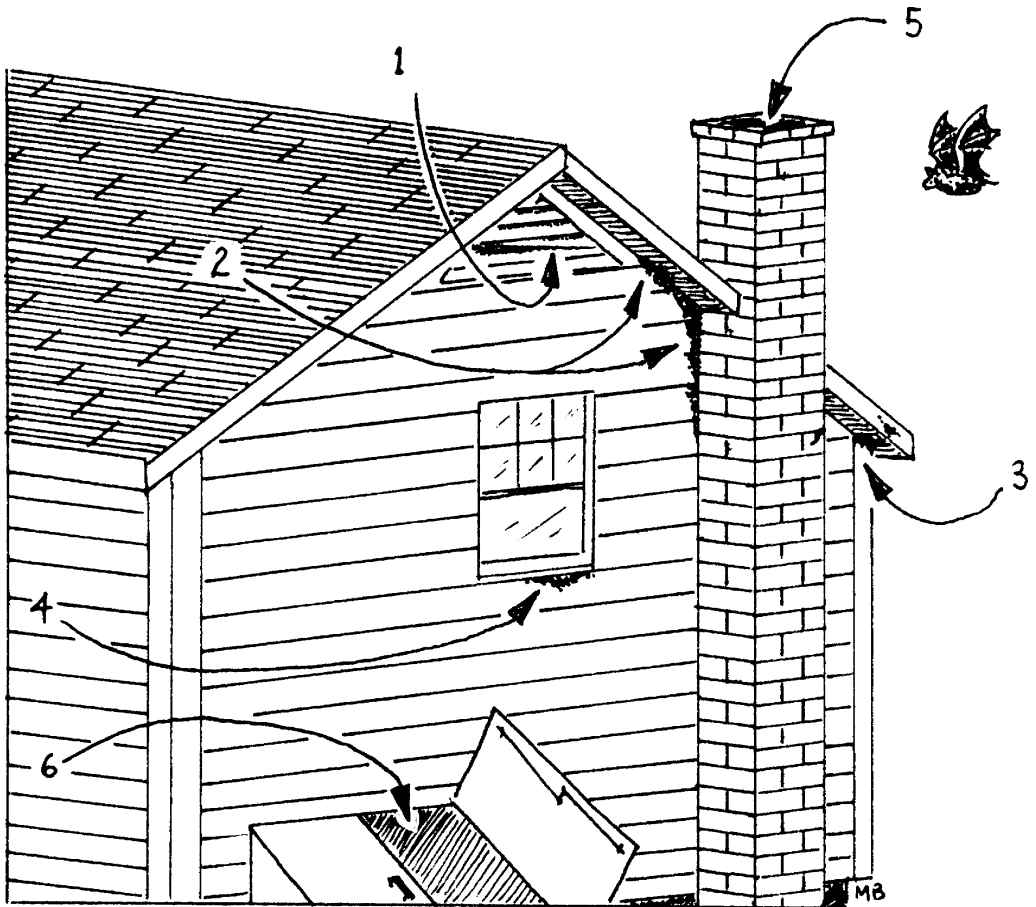

Figure 3. The most common entranceways for bats entering a home include (1) an unscreened attic vent, (2) a crack or separation where the chimney meets the house, (3) a hole or crack under a rotted eave, (4) rotted window sills or loose-fitting screens, (5) chimney flues, (6) an open cellar hatch (bulkhead). Other possible entrances include openings where pipes or wiring meet the house, and gaps in loose or warped siding.

How to Know When There is a Bat Colony in the House

The most obvious sign that a bat colony resides in your home is when you observe bats flying in and out of a hole in the house. If they become a nuisance, **discovering the entranceway(s) to the colony is the most important step in solving the problem.**

Other signs that indicate a bat colony is present include

- (1) a single bat found in the living quarters on more than just one occasion
- (2) squeaking and rustling noises, particularly at dusk or on hot summer days, in the ceiling or walls. (Mice or flying squirrels may also be responsible for such noises.)
- (3) a hole in the eaves with a dirty stain below it (see Fig. 4). As bats enter and leave a colony, they often urinate, causing a stain on the wall. Their droppings may also be splattered on the siding below the entrance hole. Be aware, however, that not all entrance holes will display a stain or splatters.

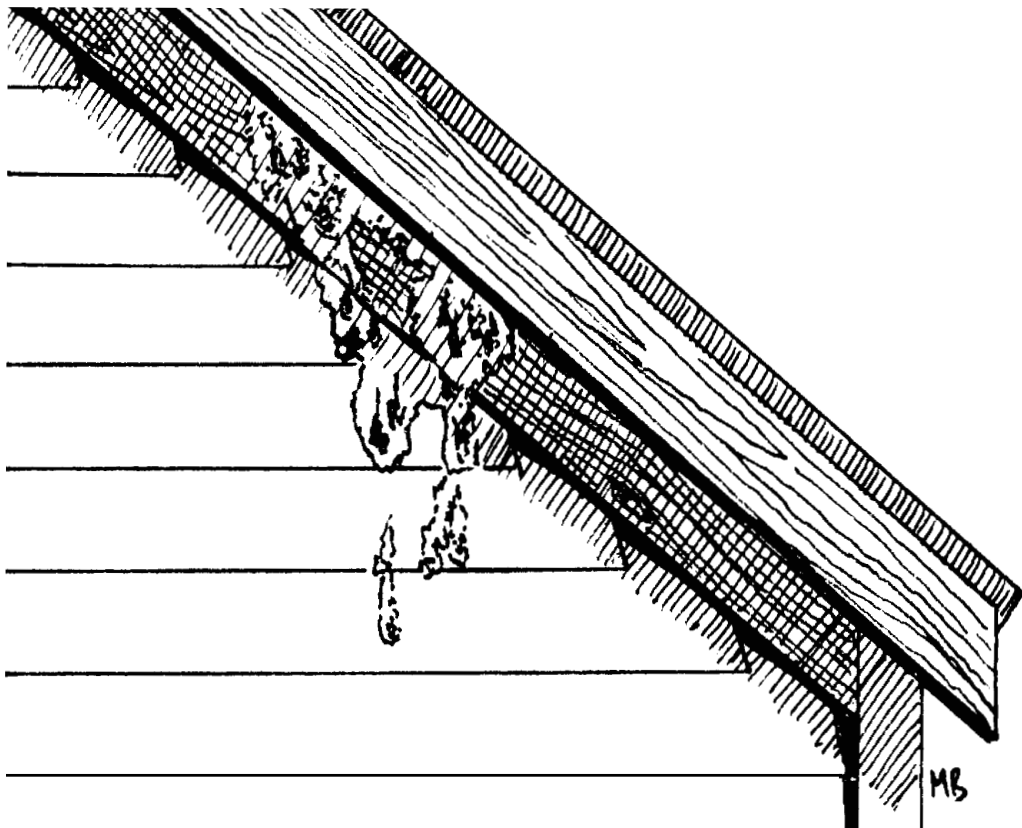

Figure 4. A typical bat colony entrance can often be recognized by a stain below it.

(4) a stain forming on the ceiling of older houses accompanied by an offensive odor. This happens only in the larger colonies and when there is no insulation protecting the attic floor. The problem is caused by a build-up of guano (feces) and urine under the roosting bats.

(5) droppings (guano) on the steps, sidewalk or patio beneath the exit hole. Guano is often pushed out of crevices and other openings where bats exit each evening.

Time of Year to Remove a Bat Colony

With few exceptions, attempts to evict a colony of bats from a building should be made only during the early spring, **during the month of May**, or late summer, **from the first of August to mid-October**. The only good long-term solution is to bat-proof the building by blocking all possible entrances when all the bats are out. Even if the bats were killed, others would soon follow if the basic problem (holes in the house) is not resolved.

During spring and fall you can temporarily block roost entrances after the dusk emergence, opening the holes for an hour at dusk for one or two subsequent evenings to let any trapped bats out. Better yet, install one-way doors over the entrances, eliminating the need to remove and replace the barriers those first few evenings.

At times other than early spring and late summer, it is unlikely that all of the bats will be away from the colony at the same time. During the summer, a colony may contain a large number of baby bats that are too young to fly and are left alone in the colony while their mothers are out feeding. From late fall through winter, some or all of the bats in a colony (see warning below) will be dormant because they hibernate through the cold months. If the entrances to a colony are blocked while bats are inside, they will search for ways out of the house and may end up in the living quarters. If they can't get out, they will eventually die and create an offensive odor in the house.

WARNING

Bat colonies in Massachusetts homes are usually composed of either big brown bats or little brown bats. While little brown bats leave buildings to hibernate in caves and mines during winter, big brown bats often hibernate right in homes. Very seldom does a homeowner know for certain if a colony is little brown bats or big brown bats; it is important, therefore, to follow the guidelines for removing bat colonies **only in the early spring and late summer**. Only if a colony is **known** to be little brown bats should a homeowner attempt to seal up the entrances during the winter (November through March).

How to Get Rid of a Bat Colony

The most important step in removing a bat colony is to discover where the bats are entering and exiting. There may be one or more such entrances in a house, and they may be quite small: a little brown bat can squeeze through a hole $5/8 \times 7/8$ of an inch, while a big brown bat can squeeze through a hole $1/2 \times 1-1/4$ inches! Since most bats leave their roost about 15 minutes after sunset, you should watch the outside of your house from 30 minutes before to 30 minutes after sunset. If possible, position yourself so that you can silhouette flying bats against an open view of the sky. Bats may be difficult to see if the area around the house is dense with foliage.

Once you have located all of the entrances, close each one **except** the primary entrance, using a good sealing material such as any of the following: caulking, screening, polyurethane foam, fiberglass insulation, polypropylene rope, flashing. Next, you should install a one-way door over the remaining hole so that bats are permitted to exit only. (Many effective designs are available; a few good examples are shown in Figures 5 and 6.)

For the next three or four nights, watch the bats as they leave. If the door is functioning properly, there should be no bats coming out by the third or fourth night. When you no longer see bats exiting the house, seal up the last hole. If you have sealed all of the holes, you will have no further problems.

If you discover that the bats are using another entrance of which you were not aware, move the one-way door to that entrance and repeat the process described above. During the first few days, returning bats that cannot get back into the attic may roost in the open under the eaves or on the side of the house, but they will soon abandon the area.

Designs for One-Way Doors

Many designs for one-way bat excluders have been created and tested and new designs could certainly be devised with a little imagination.

One type of one-way door can be made by simply caging in the bat colony entrance with wire screen (Fig. 5). The caging must be completely enclosed on the top and sides, but the bottom is open two feet below the colony entrance.

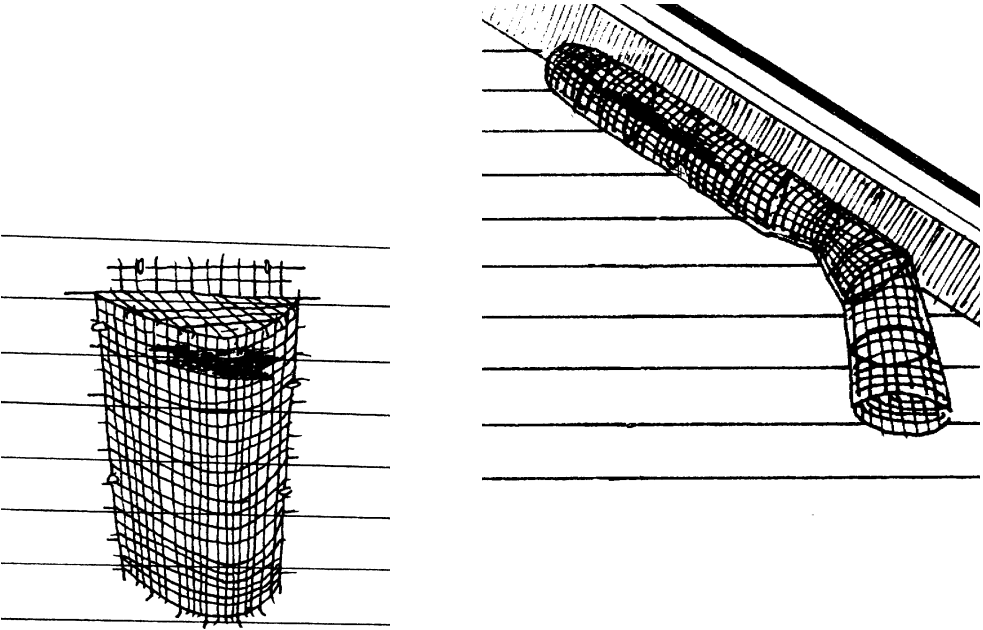

Figure 5. *Inexpensive, one-way bat exclusions can be made with wire screen. Bats can exit through the open bottom, but cannot fly up to return. Standard design, left, is ideal for holes and small gaps in siding, but can be modified, right, to cover long cracks or gaps along eaves or between siding and a chimney.*

As bats exit they can drop out of the bottom, but they cannot fly through the screen. The open bottom of the cage is too far below the entrance for most bats to re-enter through the bottom, and if they try, the cage is too narrow and long for them to fly all the way to the entrance. They could land on the side of the house and climb back to the entrance, but they seldom try that tactic. This type of one-way door can be used for a small entrance hole, or it can be adapted to cover a long open crack under the eaves or along a chimney.

Probably the easiest way to make a one-way door over a bat entrance is to use a plastic garbage bag. Slit the bottom of the bag open so that it creates a large plastic tube. Then tape or staple one of the open ends around the hole that the bats are using. As the bats fly out of the hole at night, they enter the plastic bag, flutter around and fall out the bottom. Since the bag is hanging limp, there is no way they can fly back inside and re-enter the house.

Be aware, however, that if the bag hangs flat against the hole, the bats may not be able to get *out* of the house. To avoid this problem, tape or staple a bent piece of cardboard just above the hole (see Fig. 6) to hold the plastic slightly away from the hole. This technique utilizes inexpensive materials that are readily available, and it is

easy to install over holes of various shape and location. It works well on an entrance in the form of a hole or a short crack, but it is more difficult to apply on a long crack. In that case, most of the crack can be covered with a strip of duct tape and the bag can be used to cover the short length of the crack which is left open.

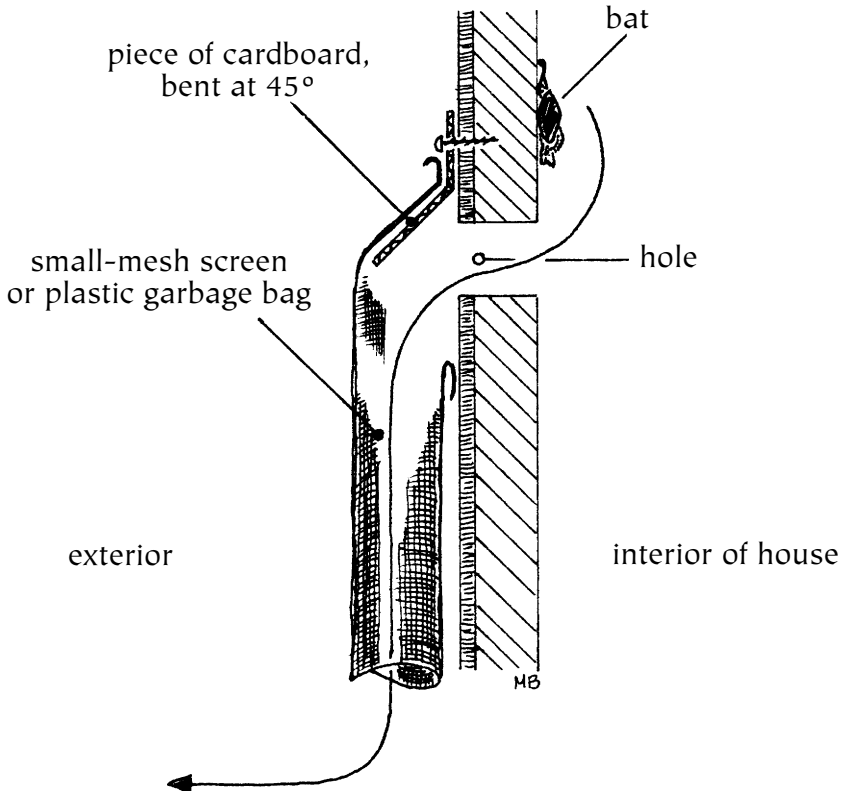

Figure 6. This highly effective, one-way bat excluder can be constructed with nothing more than a sheet of cardboard, a plastic garbage bag and a couple of screws or nails.

Preventive Maintenance

Working to keep your house weather-tight and energy-efficient is the best way to prevent bat problems. Cracks, separations, rotted eaves, rusted ventilation screens and other openings should be repaired as soon as they are noticed.

Chimneys are another common avenue of entrance. Bats and many other animals, including flying squirrels, gray squirrels, starlings, screech owls, wood ducks and raccoons frequently enter houses through the chimney. This can be prevented by covering the chimney top with a commercially available chimney cap.

Summary

(1) If you strive for a weather-tight home by using insulation in the attic and caulking all cracks and holes, your house will probably be both energy-efficient and bat-proof.

(2) If a bat colony causes a nuisance in your home, discovering the entranceway(s) is the most important step in solving the problem.

(3) Bat colonies should be excluded from buildings only in the spring (May) and late summer (first of August to mid-October) when all individuals can be excluded.

(4) The best method for excluding a colony from a building is to seal all but the main entrance hole, place a one-way door over the main hole for several days so that bats can leave but not re-enter, then seal the last hole.

(5) Poisons are illegal to use against bats (and most other wildlife) and repellents have not been shown to be effective in evicting bats.

Disease and Public Safety

Two diseases are usually associated with bats: rabies and histoplasmosis. In Massachusetts, the first rabid bat was not documented until 1961. Between 1961 and the end of 1995, a total of 325 bats (less than 8 per year) were found to be rabid by the Massachusetts Department of Public Health. The frequency of rabies in wild bats has been variously estimated from 0.1 to 0.5 percent, meaning one bat in 1,000 to one in 500 might be expected to have rabies. If we consider only bats that are found on the ground (and thus more likely to be sick) the percentage of diseased bats is higher.

In the United States and Canada through 1995, 21 people are known to have died from bat strains of rabies. The only New England case occurred in 1995 in Greenwich, Connecticut.

Since the rabies virus is transmitted almost exclusively by bites, **no bat should be handled without gloves or other protection**, and one should always take care not to be bitten. If you or someone else is ever bitten by a bat, make sure that the bat is captured and submitted for examination to the Massachusetts Department of Public Health in Jamaica Plain, Massachusetts (617-983-6800). If the bat cannot be captured, contact your physician immediately.

Histoplasmosis is a fungus associated with the droppings of bats and birds. If dust containing the fungal spores is stirred up and inhaled, a lung infection may result. Symptoms of histoplasmosis include fever, congestion, and spots on the lungs that show up on x-rays. Mild cases are common, often going unnoticed; severe cases are rarely fatal. To guard against the disease, never sweep or vacuum guano from an attic floor or stir up guano dust unless wearing an adequate protective mask.

Bat Conservation

Bat houses or boxes can be useful in providing secure roosting sites for bats, and may be especially helpful in providing habitat for bats that are displaced from dwellings. A wide variety of designs are available from the Massachusetts Division of Fisheries and Wildlife and from Bat Conservation International (see addresses at end of booklet). Figure 7 shows one design for a small nursery colony.

The location (placement) of any bat house is an important factor in determining whether or not it will be used. In Massachusetts, a bat house should face southeast or southwest so it is exposed to about 8 hours of sun each day. Bats seek out hot attics and similar places to incubate and raise their young. In New England, bat boxes placed in shady locations may not generate enough warmth to support a maternity colony. To increase the warmth of the box, the upper half can be covered with black roofing paper or it can be painted dark brown or black to absorb more heat. A vent in the lower portion of the box will provide air circulation and cooler temperatures if the upper portion of the box becomes too hot.

The box can be located on the side of a building, on a tree, or on a pole. It should be ten or more feet off the ground and should not be located where the droppings which fall out of it will become a nuisance. If possible, place the box within a quarter mile of a pond, river or wetland. If the box is intended for bats being evicted from a building, the greatest success will be achieved if it is placed on the outside wall of the building from which the bats are being evicted (or as nearby as practical).

Bats are protected by law in Massachusetts and may not be killed or captured except under permit, when they are creating a risk to public health, or when they are damaging property. Although most bats should be evicted unharmed, any individual bat found in the house that might have had contact with a pet or person, particularly children, should be turned in to the Department of Public Health for rabies testing.

For assistance in identifying a captured bat, you may wish to bring the bat or submit a photo to one of the authorities listed below:

Dr. Thomas W. French
MassWildlife
Field Headquarters
One Rabbit Hill Rd.
Westboro, MA 01581
Tom.French@state.ma.us

Dr. Gwilym S. Jones
Dept. of Biology
Northeastern University
360 Huntington Avenue
Boston, MA 02115
g.jones@neu.edu

For information on submitting specimens to be tested for rabies, contact:
Department of Public Health
Diagnostic Laboratory
Jamaica Plain, MA 02130
(617) 983-6800

If you wish to learn more about bats, you can begin with the following list. Your town, city or local college or university library may have these or other useful references.

- Barbour, R.W. and W.H. Davis 1969. *Bats of America*. University Press of Kentucky, Lexington, 286pp.
- Fenton, M.B. 1983. *Just Bats*. University of Toronto Press, Toronto, 165pp.
- Graham, G.L. 1994. *Bats of the world*. Golden Press, N.Y., 160pp.
- Hill, J.E. and J.D. Smith. 1984. *Bats: A Natural History*. University of Texas Press, Austin, 243 pp.
- Kunz, T.H. (ed) 1982. *Ecology of Bats*. Plenum Publ. Corp., N.Y., 425pp.
- Mohr, C.E. 1976. *The World of the Bat*. J.B. Lippincott, Philadelphia, 162pp.
- Schober, W. 1984. *The Lives of Bats*. Arco Publishing, Inc., N.Y., 200pp.
- Tuttle, M.D. and S.J. Kern. 1981. *Bats and Public Health*. Milwaukee Public Museum Contributions in Biology and Geology. No. 48: 1-11.

Anyone interested in bat conservation should contact: Bat Conservation International, P.O. Box 162603, Austin, Texas 78712, phone (512) 327-9721. This organization offers the best and largest assortment of bat house plans available anywhere, and is continually developing and testing new designs.

Suggestions for Building Bat Houses & Attracting Bats

Bat houses have been used successfully for a variety of bat species in Europe and North America. Their exact size and shape are probably not important except for the width of the entry spaces. These should not exceed one inch, with the ideal width being only 3/4 of an inch. Regardless of the kind of house built, all inner surfaces must be rough enough to permit the bats to climb on them with ease, and rough outer surfaces are preferred.

Young bats grow best where daytime temperatures are in the 80-90°F range. For this reason, maternity colonies are most likely to use bat houses that either provide temperatures in this range or that are so well insulated that body warmth is easily trapped. Europeans often cover their bat houses on top and for an inch or two down the sides with two or more pieces of tar paper. The dark covering absorbs heat from the sun by day and provides added insulation by night, in addition to protecting the bats from rain.

Several means of insulating or providing a range of temperatures in bat houses are available, but as yet, largely untested. One involves covering bat houses with styrofoam on top and on all four sides. An additional covering of dark colored shingles or tar paper might prove helpful, especially in northern areas where the bats may need higher temperatures. Making the bat house illustrated here with only the upper six inches and top covered with dark material might provide an even better range of temperatures. By moving up and down and from front to back, bats could always find roost temperatures to their liking. Paint or varnish is reportedly somewhat repellent to bats, at least until well cured.

Bat houses should be fastened securely to a tree trunk or the side of a building roughly 12-15 feet above ground, preferably where they will receive morning sun but will be shaded during the afternoon. Inside temperatures above 90° F generally are intolerable. For this reason, a well insulated bat house that receives only morning sun should prove most suitable. Male bats do not live with the females while young are being reared, and these bachelor colonies may be attracted to sheltered, cooler locations. Additionally, most bats seem to prefer sites that are relatively protected from wind.

It is important to note that bats can live only where local food supplies are adequate. For this reason, most colonial bats are found near places such as rivers, lakes, bogs or marshes where insect populations are high. The closer bat houses are to such places, the greater the probability that the houses will be used. Those located more than one-half mile from these habitats have a greatly reduced probability of being occupied.

Sometimes bats occupy a bat house within a few weeks. Often, however, bats require a year or two to find the new house. Chances of early occupancy are probably increased if houses are hung before or by early April and also if bats already live in barns or attics in adjacent areas.

Since use of bat houses is very new in the United States, we have much to learn about local bat preferences. Your reporting of successes and failures in building houses for bats could contribute measurably to our knowledge of how to attract bats. Write to Bat Project, MassWildlife, Massachusetts Division of Fisheries & Wildlife, Field Headquarters, Westboro, MA 01581. For more bat house designs, contact Bat Conservation International, P.O. Box 162603, Austin, TX 78712 (phone 512-327-9721).

Figure 7. Exploded view of a simple bat house design.
 Many more elaborate designs are available.

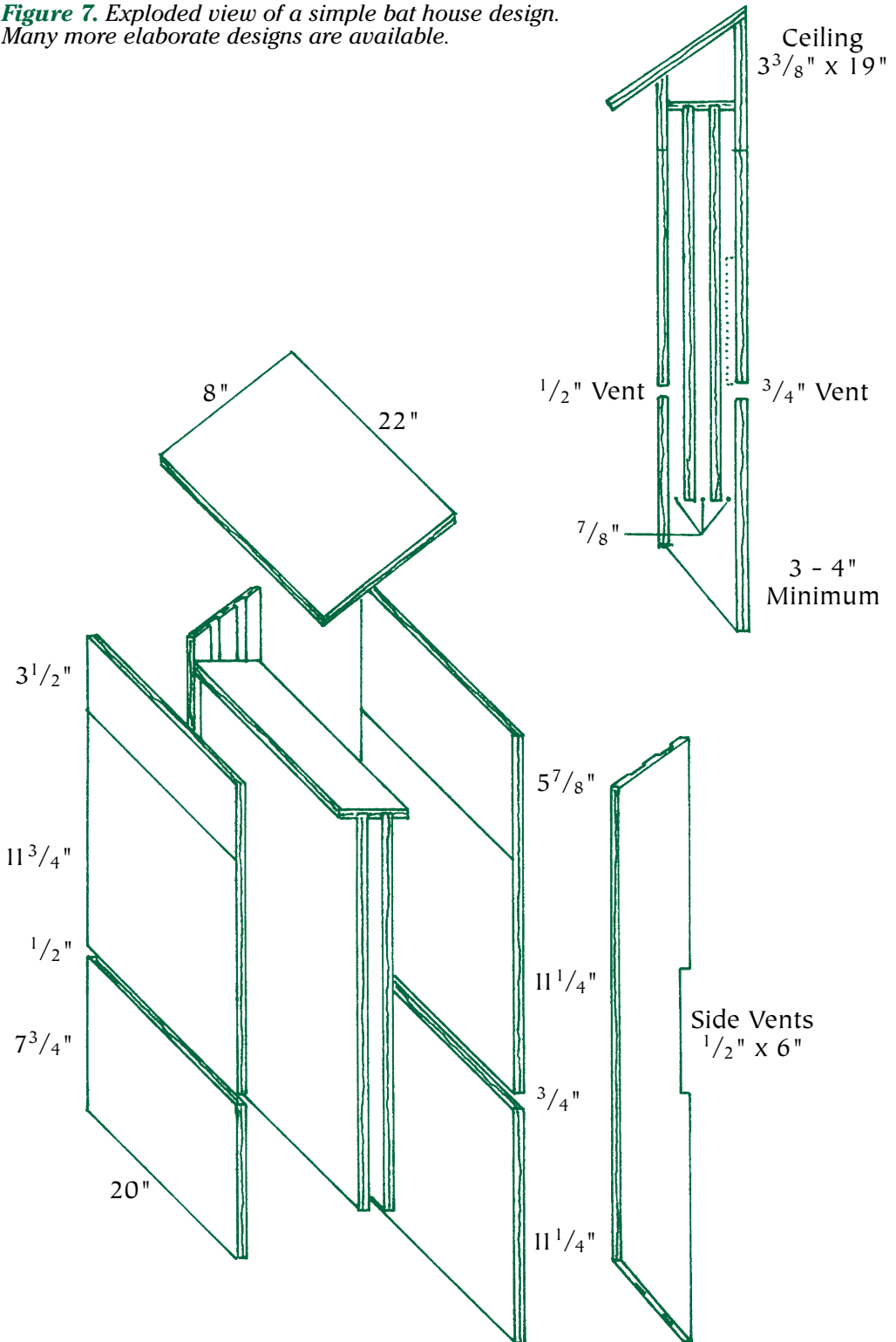

Key to the Bats of Massachusetts

A key is the most effective tool for identifying a plant or animal, in this case a bat. If you have never used taxonomic keys, be assured that they are easy to use. Each number offers you a choice. Begin with Number 1. If the bat does not fit the description for 1a, then it will fit the description for 1b. If, for instance, it matches 1b, follow the directions which state “go to 4a.” Continue determining which description fits, 4a or 4b, et cetera, until you discover the common name of your particular bat.

- 1a. Upper surface of interfemoral membrane (See Fig. 1) either completely or half covered with hair; tips of many body hairs white, causing frosted appearance go to 2a
- 1b. Upper surface of interfemoral membrane without hair; body hairs do not have white tips go to 4a
- 2a. Except for white tips, hair is rusty in color RED BAT
- 2b. Except for white tips, hair is dark brown or black go to 3a
- 3a. Interfemoral membrane completely covered with hair; forearm 1-3/4 to 2-1/4 inches long HOARY BAT
- 3b. Only 1/2 of interfemoral membrane (nearest the body) covered with hair; forearm 1-1/2 to 1-3/4 inches long SILVER-HAIRED BAT
- 4a. Hairs on back tricolored — dark at base and tip, but lighter in the middle EASTERN PIPISTRELLE
- 4b. Hairs on back bicolored — dark at base and light at tip go to 5a
- 5a. Forearm greater than 1-3/4 inches long BIG BROWN BAT
- 5b. Forearm less than 1-3/4 inches long go to 6a
- 6a. Face with black mask; ears black; forearm less than 1-3/8 inches long SMALL-FOOTED BAT
- 6b. Face with no black mask; ears not black; forearm longer than 1-3/8 inches long go to 7a
- 7a. Ears very long, when laid forward extend 1/16 inch (4mm) beyond nose NORTHERN LONG-EARED BAT
- 7b. Ears relatively short, when laid forward do not extend beyond nose or as much as 1/16 inch go to 8a
- 8a. Hair glossy; calcar (see Fig. 2) not keeled LITTLE BROWN BAT
- 8b. Hair dull; calcar keeled INDIANA BAT

Massachusetts Bat Species

Species of bats that occur in Massachusetts with their habitats, distribution and status of the uncommon species noted.

COMMON NAME	SPECIES	RANGE IN MASSACHUSETTS			HABITAT		NOTES
		statewide	probably statewide	statewide	buildings, trees	buildings, caves, mines	
Big brown bat	<i>Eptesicus fuscus</i>	statewide	probably statewide	statewide	buildings, trees	buildings, caves, mines	
Little brown bat	<i>Myotis lucifugus</i>	statewide	probably statewide	statewide	buildings	caves, mines	
Northern long-eared bat	<i>Myotis septentrionalis</i>	probably statewide	probably statewide	probably statewide	trees, building exteriors, rarely inside buildings	caves, mines	
Indiana bat	<i>Myotis sodalis</i>	last recorded: 1939. Berkshire, Hampden & Worcester Counties	known only from Hampden County	known only from Hampden County	caves, mines, hollow trees, beneath tree bark	caves, mines	ENDANGERED (Federal & State)
Small-footed bat	<i>Myotis leibii</i>	statewide	probably statewide	statewide	beneath tree bark; occasionally in buildings	caves, mines	SPECIAL CONCERN
Eastern pipistrelle	<i>Pipistrellus subflavus</i>	statewide	probably statewide	statewide	trees, rarely in buildings	caves, mines, rock crevices	
Silver-haired bat	<i>Lasiorycteris noctivagans</i>	probably statewide	probably statewide	probably statewide	trees rock crevices	buildings, trees, (migratory)	
Red bat	<i>Lasiurus borealis</i>	statewide	statewide	statewide	tree foliage	migratory	
Hoary bat	<i>Lasiurus cinereus</i>	statewide	statewide	statewide	tree foliage	migratory	



MassWildlife
Massachusetts
Division of Fisheries & Wildlife

Field Headquarters • One Rabbit Hill Road
Westboro, MA 01581 (508) 792-7270
www.masswildlife.org